

Preparing For Delivery

Preparing the Space: Please make sure that the rooms are clear and ready to go.

1. Flooring to be down & installed.
2. Paint & ceilings done.

For new offices installations...



GOOD 😊



BAD 😡

For office reconfigurations...



GOOD 😊



BAD 😡

Delivery Requirements (if you haven't checked already):

Please verify delivery requirements such as freight delivery hours & reservation, masonite protection, Certificate of Insurance, Union labor requirements, etc. with your building management.

Preparing for Electrical

Electrical Capacity: How much electricity will your office appliances consume?

As a rule of thumb, cubicle receptacles are not equipped to support high amperage equipments like large copiers and space heaters.

Typical Power Usage by Common Office Furniture

NOTE: Please check the amperage requirements that are identified on the UL labels of all office items requiring power.

Personal Computer	3 AMPS	Small Inkjet Printer	3 AMPS
Notebook Computer	3 AMPS	Laser or LED	3 AMPS
17" Color Monitor	2~3 AMPS	36" Task Light	2 Bulb / Amp
21" Color Monitor	2~3 AMPS	48" Task Light	3 Bulb / Amp
Desktop Copier (1 circuit)	25 AMPS	Personal Space Heater	⊗
Console Copier	30 AMPS	Microwave	⊗



Preparing an Electrician: This is required if you are ordering electrified cubicles.

Electrical whip to be hard wired by a licensed electrician. This is usually provided by a General Contractor or by the client (buyer).

Pre-Installation Requirements:

The electrical distribution system is a 4-circuit, 8 wire modular system that can supply up to four circuits with single phase or three phase power. Each circuit is rated 125 volts, 20 amperes and can supply a maximum of 13 receptacles.

• Before starting the installation of the electrical distribution system, be sure to coordinate the final layout with the electrician to determine any prewiring to be completed prior to scheduling the installation.

NOTE: Similarly the network wiring contractor must be coordinated for telecommunication cable, and computer cable supply points

• Connection of electrical components to the building electrical supply must be made by a licensed electrician.



Preparing for Electrical

On installation day:

You should have your Electrician present so they can do the hardwiring at the same time as our installers are building the cubicle work stations.

WARNING: Installation of electrical components should be done by a licensed electrician. Disconnect power prior to servicing the system. Failure to do so can result in electric shock and/or personal injury.



The furniture installers will take care of the electrical wiring within the cubicles, and your electrician will need to connect/hardwire them into the building's power.

PREPARING FOR ELECTRICAL

Base Infeed: A hardwiring electrical connection from a wall, column, or floor.

To assure proper interconnection with the building sources in walls or columns, the panel selected for power entry must be within six feet of the building supply point. Power Connection to building requires a certified electrician.



6' Power Base Infeed
8 wire, 4 circuit

Available as either left or right handed with a 6' flexible covered wiring (whip). The infeed will attach onto the power harness at either receptacle locations (left or right) by snapping into the receptacle housing. This allow maximum use of the whip length. The arrow on the right side of the infeed must be pointing up to connect it into the receptacle housing.



Left going left



Right going left



Right going right



Left going right



Left



Right

base infeed on your furniture layout

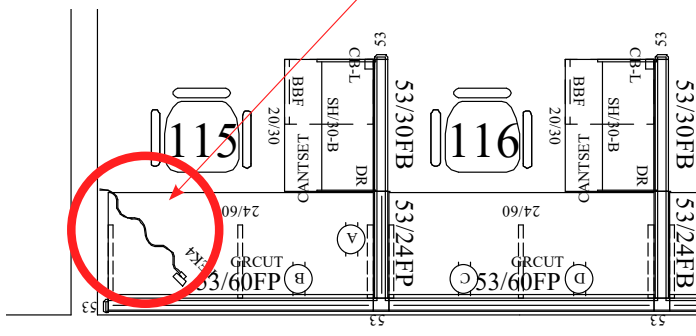

*symbol may vary depending on cubicle manufacturer

Power From Floor

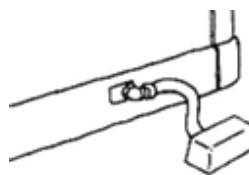

Power From Building Wall

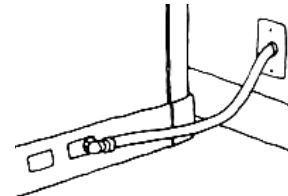

Data Cables

Base Infeed from floor core



Base Infeed from wall

Data Cables



PREPARING FOR ELECTRICAL

Ceiling Infeed: A hardwiring electrical connection from the ceiling.

To assure proper interconnection with the building's wiring above a suspended ceiling, accessible ceiling tiles must be available immediately above the desired power entry point of the electrical distribution system plan. Building electrical supply junction boxes must be close to the ceiling supply point above the suspended ceiling.



Ceiling infeed 2"x2" size

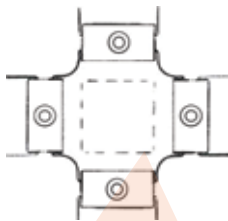

Attach by passing through a 3-way or 4-way Connector top caps must be cut to allow pass-through.

OR: Screw or tape to the side of an end cap, 3-way, or 4-way.

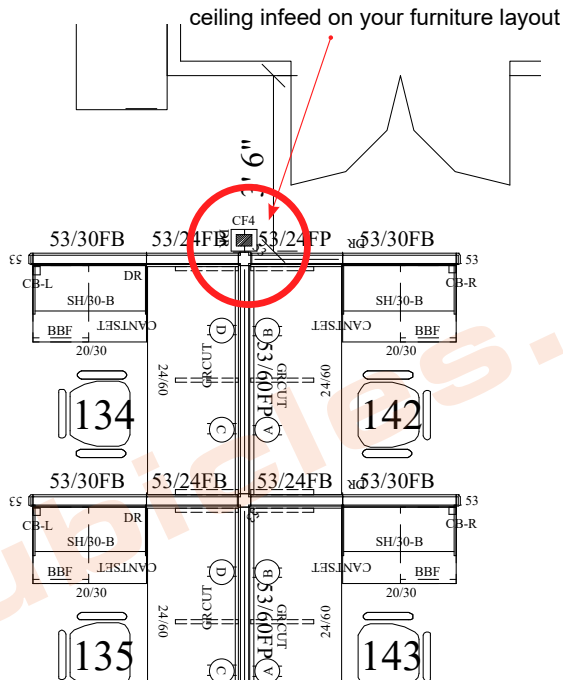

*symbol may vary depending on cubicle manufacturer



Ceiling infeed 3"x4" size

Place at the End of a Panel

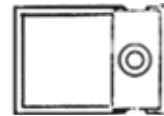

Convert a 2-Way to a 3-Way

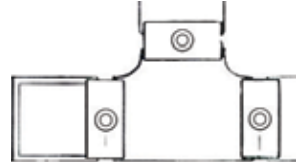

Convert a 3-Way to a 4-Way

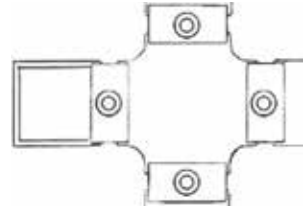

Attach by connecting pole hardware to panel or connector rail.

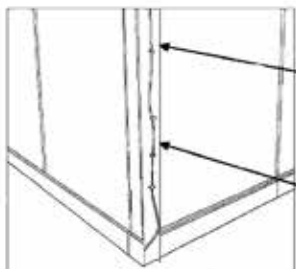

Ceiling Infeed Installed in Power Pole Case

- Power Pole includes:
- [1] 10" Piece Rigid Conduit
 - [3] Straps for Flexible Conduit
 - [1] 14' Ceiling Power Feed
 - [1] Top Trim
 - [1] Base Trim

Top Termination Trim For Ceiling

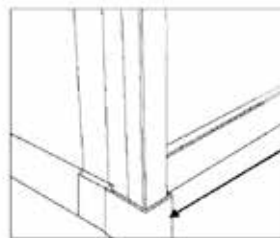
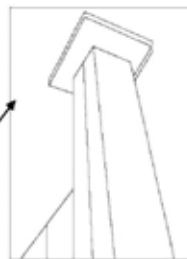

Bottom Trim for Power Pole

POWER DISTRIBUTION & CABLING INFORMATION

BASE FEED OPTION

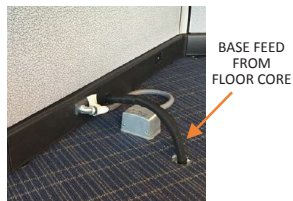
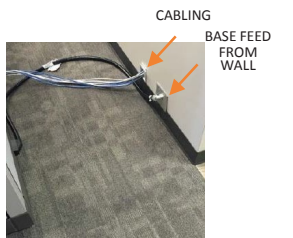

CEILING FEED OPTION

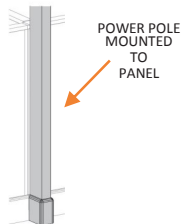

- Client to provide electrician for hardwiring the building power to the cubicle power feed at the time of installation. It is recommended the electrician review the final layout to determine any pre-wiring to be completed prior to scheduling the installation.
- Client to provide communication (aka telephone, cabling, data lines) to route cabling. It is recommended the communication installers review the final layout to determine any pre-wiring to be completed prior to scheduling installation.

Our powered panels run on an 8 Wire / 4 Circuit system. Electrical circuits A, B, C and D are active with alternating current and must be tied to a Ground and a Neutral when powering. D is a dedicated circuit and must have an isolated Ground and isolated Neutral to power.

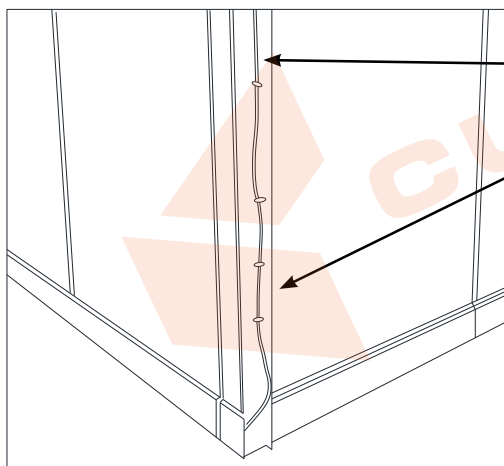

FIGURE 1a
Ceiling Feed Installed in Power Pole Case
Power Pole Includes:
1 - 10' piece rigid conduit
3 - straps for flexible conduit
1 - 14' ceiling power feed
Top trim
Base trim

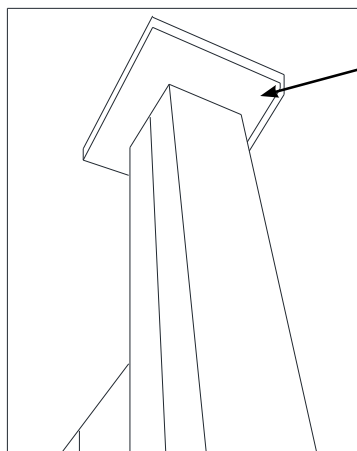

FIGURE 1c
Top terminating trim for ceiling

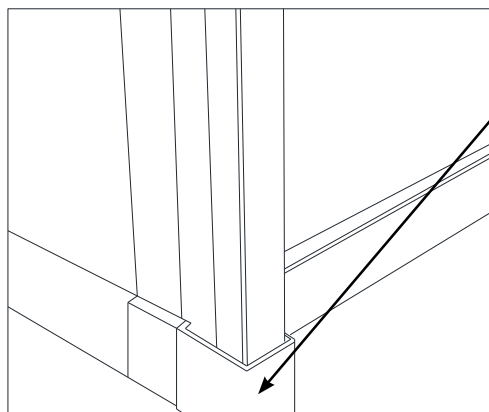

FIGURE 1b
Bottom trim for power pole

PREPARING FOR ELECTRICAL

Electrical Diagram: Graphical representation of an electrical circuit.

Please forward installation diagrams to your Electrician/Data Technician so they are prepared.

Note: certain union buildings may have different regulations on who is approved to perform electrical duties; check with your building manager in advance

O2 cubicles run on an 8 Wire/4 Circuit system. Electrical circuits A, B, C & D are active with alternating current and must be tied to a Ground & a Neutral when powering. D is a dedicated circuit and must have a Isolated Ground and Isolated Neutral to power.



- White/Pink- Neutral Dedicated
- White/Blk Writing- Neutral Shared
- Green/Yellow- Ground Isolated
- Green- Ground Shared
- Pink- D
- Blue- C
- Red- B
- Black- A

CONNECTION TO A GROUNDED THREE-PHASE SYSTEM

RATING: 120/206v, 3-PH WYE, 60 Hz, 20 AMP (CSA 15 AMP) WHITE #1, WHITE #2 RATED AT 20 AMP (CSA 26 AMP) MULTIWIRE BRANCH CIRCUIT

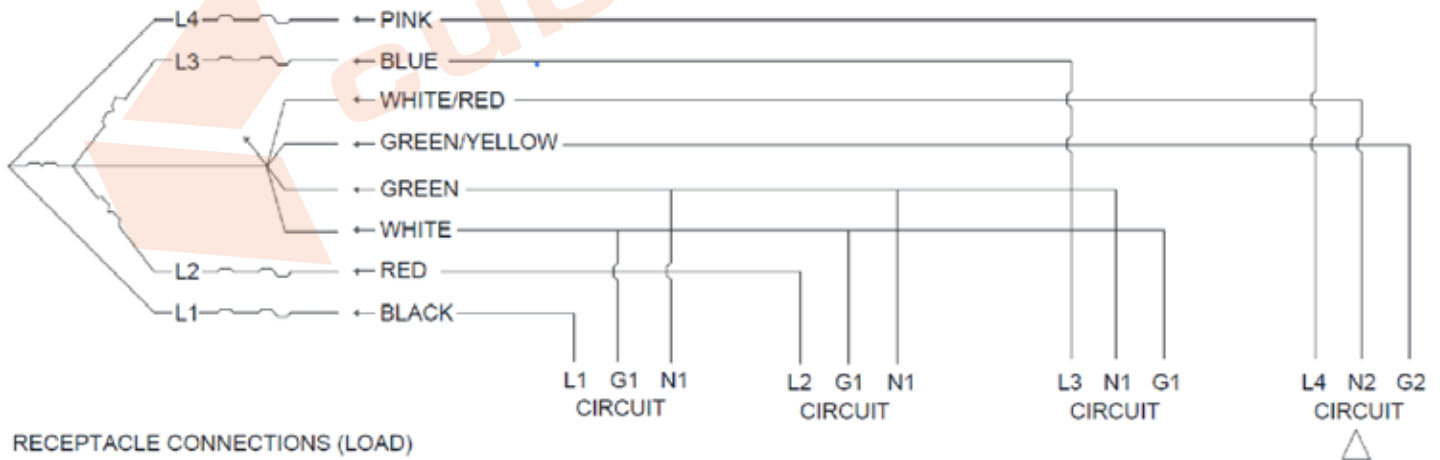

RECEPTACLE CONNECTIONS (LOAD)



LEGEND

- L1 = A Circuit
- L2 = B Circuit
- L3 = C Circuit
- L4 = D Circuit
- G1 = Ground 1
- G2 = Ground 2
- N1 = Neutral 1
- N2 = Neutral 2- Heavier Gauge Copper
- △ = Dedicated Circuit

ELECTRICAL DISTRIBUTION & WIRE MANAGEMENT

Energy distribution components are modular in nature and allow total integration with the Action Office Series 2 System. This information should be read thoroughly prior to the installation of any Action Office Series 2 System product when the electrical distribution components are to be installed.

Electrical Distribution

WARNING:

Disconnect power before servicing. Failure to do so can cause electrical shock and personal injury.

A. Pre-Installation Requirements

The electrical distribution system is a four-circuit, eight wire modular system that can supply up to four circuits with single phase or three phase power. Each circuit is rated 125 volts, 20 amperes and can supply a maximum of 13 receptacles.

Before starting the installation of the electrical distribution system, be sure to coordinate the layout with building power sources, telecommunication cable and computer cable supply points. Connection of electrical components to the building electrical supply must be made by a qualified electrician.

B. Power, Telecommunication and Computer Cable Entry

To assure proper access to the panel product's electrical distribution system and wire management channel, the interface of the building supply points and the furnishings must be carefully planned. There are generally two types of building supplies:

CEILING SUPPLY:

To assure proper interconnection with the building's wiring above a suspended ceiling, accessible ceiling tiles must be available immediately above the desired power entry point of the electrical distribution system plan. Building electrical supply junction boxes must be close to the ceiling supply point above the suspended ceiling. SEE FIG. 1A, 1B AND 1C.

PERIMETER AND COLUMN SUPPLY:

To assure proper interconnection with the building sources in walls or columns, the panel selected for power entry must be within six feet of the building supply point. SEE FIG. 2, 2A AND 2B.

Power Connection to building requires a certified electrician.

C. Telecommunication and Computer Cabling

Access of the wire management channel is independent of the electrical system. A maximum of thirty CAT 5 cables can be placed in the powered panel base. See diagram below.

D. Cable Capacity

Non-Powered Capacity- 60 CAT 5.

CF4 is a power pole with an electrical harness.
CF4 Capacity- 60 CAT 5 with power harness.

PP4x4 is a wire management pole.
PP4 x 4 Capacity- 70 CAT 5.

BASE COVER CAPACITY

B1 AND B2 base

will hold approx 30 cat 5 in a **powered base**.
(non powered panels can hold approx 60 cat 5 cables)

Thin base

will hold approx 15 cat 5 in a **powered base**.
(non powered panels can hold approx 30 cat 5 cables)

POWER POLE CAPACITY

CF4- Approx 60 cat 5 cables w/ the shielded **power feed**

CF4N- Data pole only approx 70 cat 5 cables

CF2 -Approx 12 cat 5 cables w/ the shielded **power feed**

CF2N- Data pole only approx 25 cat 5 cables

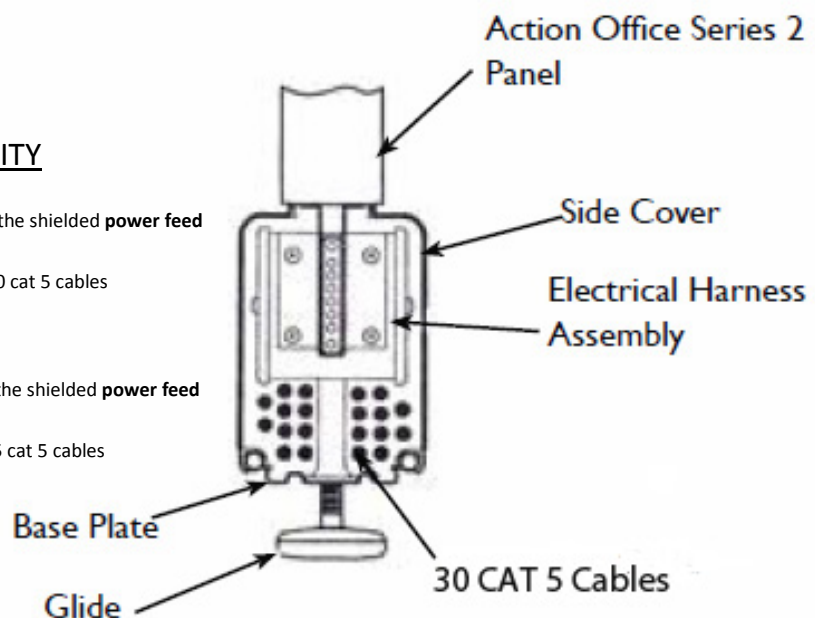

ELECTRICAL DISTRIBUTION SYSTEM CONNECTION & RECEPTACLE INSTALLATION

WARNING

Disconnect power before servicing. Failure to do so can cause electrical shock and personal injury.

NOTE: Before interconnecting the electrical components, all panels must be installed according to the Action Office Series 2 System floor plan.

NOTE: For ease of installation, start at power entry panels and proceed making connections through the system.

NOTE: Electrically interconnected panels must be mechanically interconnected.

Connection of Action Office Series 2 System Panels: SEE FIGURES 1 THROUGH 8 for description of components and details of installation.

Use the flexible connectors supplied with each panel to connect the electrical distribution assembly in the panel base. The flexible connector may be used to make connections across two-way, three-way or four-way panel junctions. SEE FIGURES 17 THROUGH 19 for examples of installations.

WARNING

All electrical connections must be fully engaged and locked. Loose connections can cause fire and/or electrical shock.

Panel to Panel Connection:

Position the flexible connectors so that the side ports are opposite each other. Press the connectors together. When fully engaged, the four ramps will be seated in the slots. SEE FIGURE 1. Disengage by pulling the connector apart.

Straight Panel Connection:

When installing flexible connectors in a panel run that includes two-way 180 panel connectors, the straight connection is used for opposing panels. Position other flexible connectors in their extended position. See figures 4 and 5. Align the connectors and install at the end ports. Be sure to fully install connectors so that all connector latches engage the mounting ramps on the opposing connector. SEE FIGURE 2. Disengage by depressing all latches until they are clear of ramps and separating connectors. SEE FIGURE 2.

Side Connection:

When installing flexible connectors in a panel run that includes 2-way 90, three-way, four-way or ceiling entry connectors, the side connection is used. Position the flexible connector in its extended position. SEE FIGURE 5. Align the end port with the appropriate side port and fully install so that connector latches. Engage the mounting ramps on the adjacent connector. SEE FIGURE 3.

FIGURE 1

Panel to Panel Connection

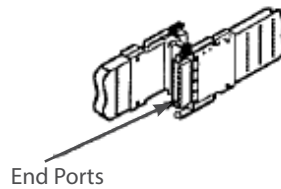

FIGURE 2

Straight Connection

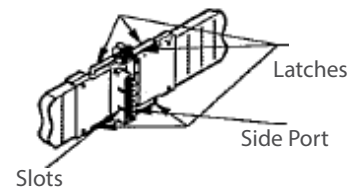

FIGURE 3

Side Connection

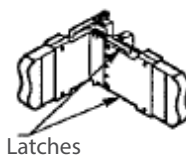

FIGURE 4

Normal Position

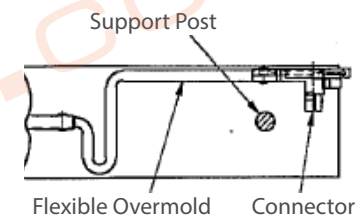

FIGURE 5

Extended Position

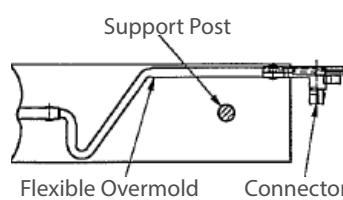

FIGURE 6

Electrical Distribution Assembly 12" & 18"

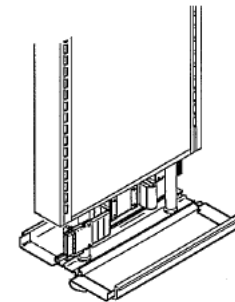

FIGURE 7

Electrical Distribution Assembly 24" through 60"

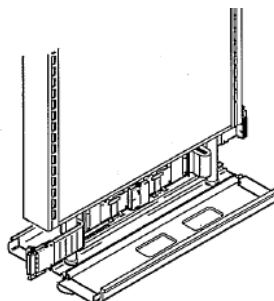
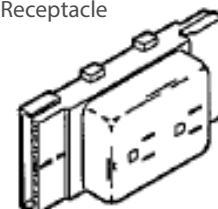

FIGURE 8

Receptacle



RECEPTACLE INSTALLATION & REMOVAL

WARNING

Disconnect power before servicing. Failure to do so can cause electrical shock and personal injury.

WARNING

All electrical connections must be fully engaged and locked. Loose connections can cause fire and/or electrical shock.

NOTE: Receptacles can be installed on both sides of the panels. Two receptacles per side can be installed on 24" through 60" panels. No receptacles can be installed on 12" and 18" panels.

NOTE: In a prominent location, not more than 12 outlets shall be supplied by one circuit.

INSTALLATION

1. Place the receptacle into the bracket to one side of the bracket hooks. See figure 17.
2. Press the spring tab and slide the receptacle connector into position to engage the electrical distribution assembly. SEE FIGURE 18. Press the receptacle further so that the connector is fully inserted and the mounting lugs are seated in the bracket hooks. When properly installed, the spring tab will snap back between the bottom mounting lugs. SEE FIGURE 18 AND 19.

REMOVAL

1. Depress spring tab located below the receptacle between the mounting lugs. SEE FIGURE 18.
2. Slide receptacle away from the electrical distribution assembly until the mounting lugs clear the bracket hooks. The receptacle can now be pulled away from the panel. SEE FIGURES 17 AND 18.

FIGURE 17

Brackets and Receptacles

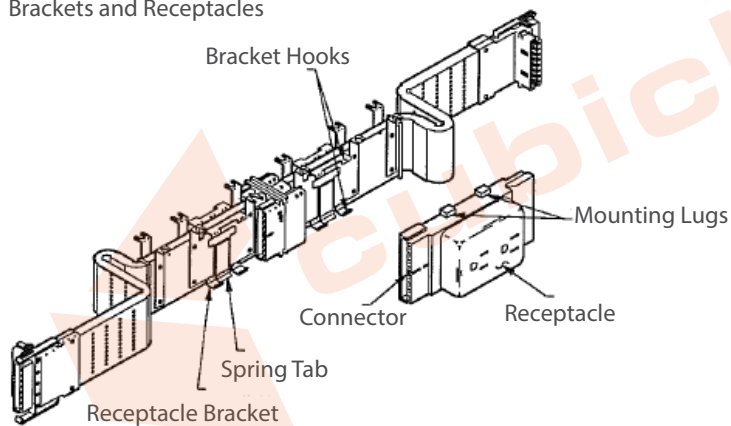

FIGURE 19

24" through 60" Electrical distribution assembly with receptacle installed

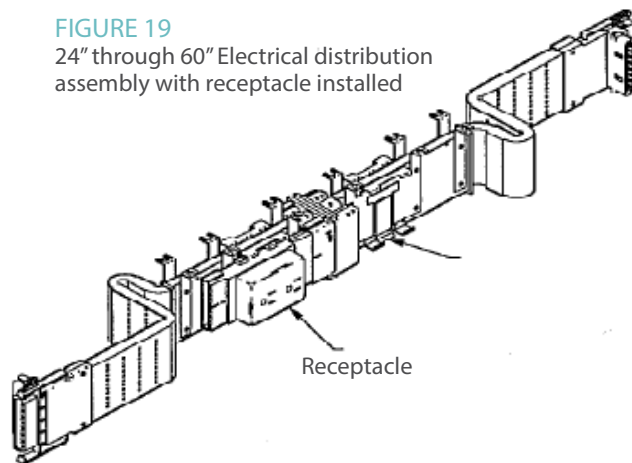
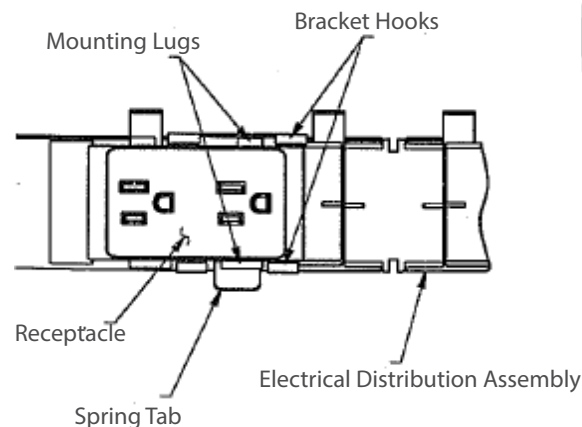

FIGURE 18

Receptacle Installation



CABLE MANAGEMENT COMPONENT INSTALLATION

SIDE COVERS:

Side covers are completely installed on Action Office Series 2 System panels. The side covers are captured by the top channel and pivot at the base plate. SEE FIGURE 1.

CABLE MANAGEMENT CHANNEL ACCESS:

A. Starting at one end, press on the side cover at the top and pull back so that the lip is clear of the top channel. SEE FIGURE 2.

B. With one end of the side cover clear of the top channel, press and pull back at several points down the length of the side cover until it is completely free of the top channel. The side cover can then be rotated to allow access to the cable management channel for cable or flexible connector installation. SEE FIGURE 3.

Side Cover Closure:

NOTE: Trim covers must be closed before closing side covers.

A. Starting at one end press down on the top of the side cover and push the lip under the top channel. SEE FIGURE 1.

B. With one end of the side cover in position, push down and in at several points along the length of the side cover until the lip is evenly installed under the top channel.

Trim Covers:

Trim covers are completely installed on all Action Office Series 2 System connector products. Trim covers are assembled to the support posts on the 90° two-way and 180° degree two-way and three way connectors. SEE FIGURES 4, 5 AND 6.

Trim covers have latches that engage the panel connector and hold the trim cover in position. SEE FIGURES 5 AND 7.

Cable management channel access:

Press down on the top of the trim cover near the center. When the trim cover latch clears the edge of the connector, rotate the cover back. SEE FIGURE 7.

Trim Cover Closure:

Rotate the trim cover to its vertical position. Press down and in at the top of the cover until the latch snaps under the connector. SEE FIGURE 7.

NOTE: Trim covers must be closed before closing side covers.

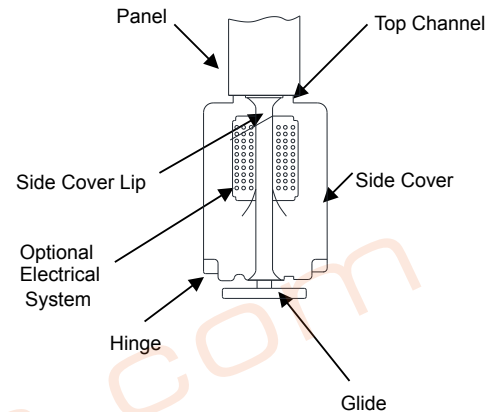

FIGURE 1
Cable Management Channel

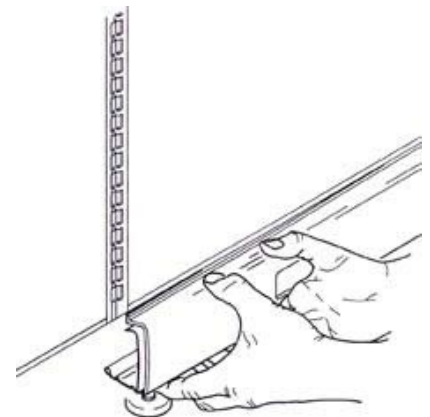

FIGURE 2
Side Cover Release

FESTOONS

V1 POWER FESTOON EXAMPLES

FESTOON 19 ■
panel to panel connection

FESTOON 23 ■
going straight through a 3-way or 4-way only

No Festoon 22 needed with OPS2
OPS2 with V2 power does not require any festoons

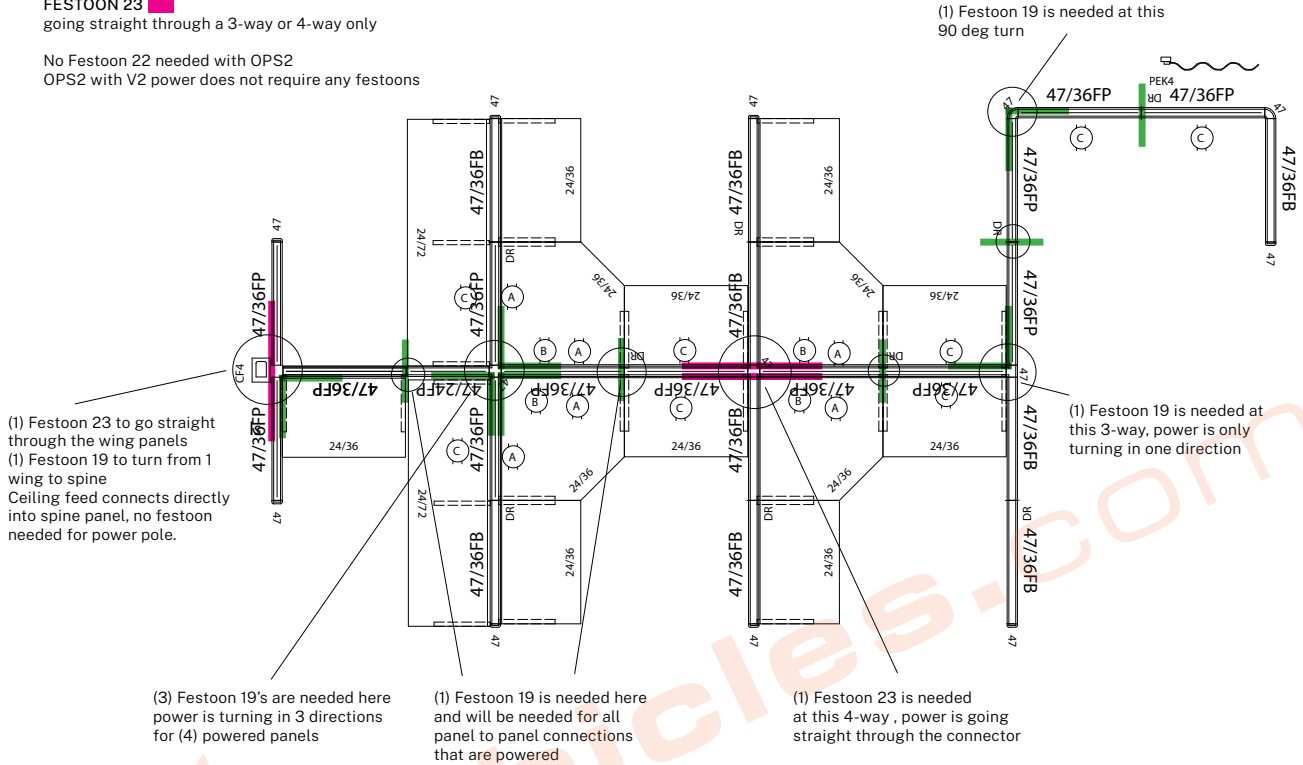

V1 POWER FESTOON EXAMPLES

FESTOON 19 ■
panel to panel connection

FESTOON 22 ■
90 deg turns

FESTOON 23 ■
going straight through a 3-way or 4-way only

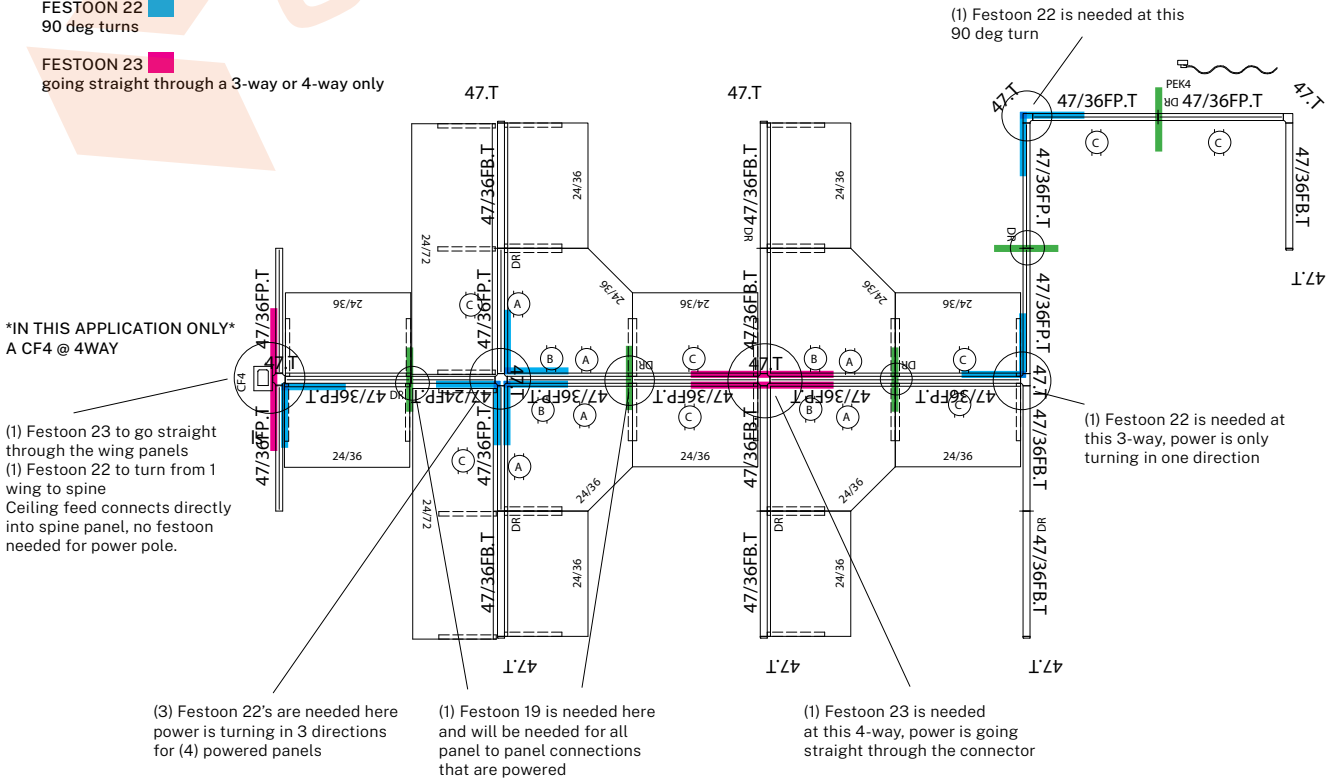

PREPARING FOR DATA WIRING

Data Wiring: How many wires will you need to run?

Data cables (low voltage wiring) will need to be run by a data technician.

The cubicles will not be supplied with data jacks & wires. They just come with data covers.

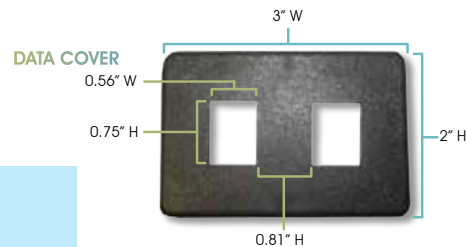

Depending on the # of cables you need to run, you can select between 2 panel types.

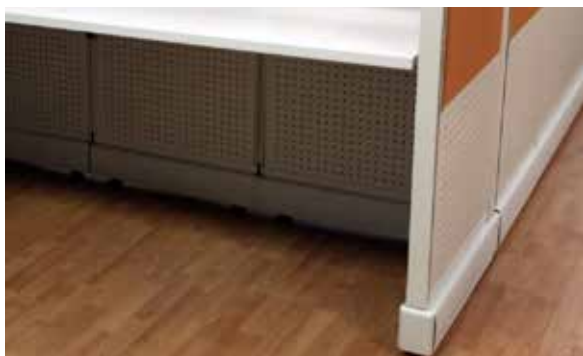

Powered Thick Base Panel- up to [30] CAT 5 cables
Non-powered Thick Base Panel- up to [60] CAT 5 cables



Powered Thin Base Panel- up to [15] CAT 5 cables
Non-powered Thin Base Panel- up to [30] CAT 5 cables

If using power poles...



Preparing a Data Technician:

Client to provide data technician to route cabling (aka low voltage, telephone, cabling, data lines). It is recommended the data technicians review the final layout to determine any prewiring to be completed prior to scheduling the installation.

PREPARING FOR DATA WIRING

On installation day:

You should have your Data Technician present so they can run their data/cables through the panel raceways at the same time as our installers are building the cubicle work stations.

It's also a huge help to already have the data cables pulled in the proper locations so it's easier for your IT person once the cubicles have been built.

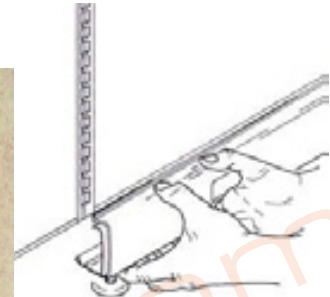
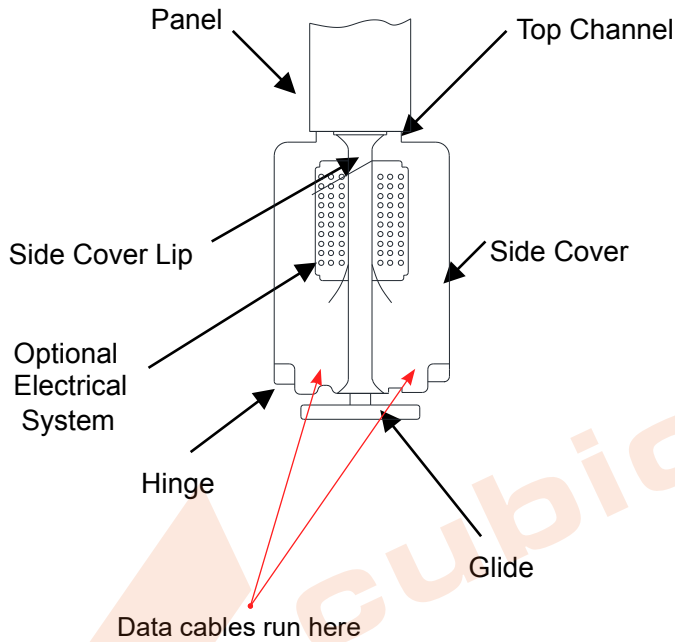

How to open the base cover

DATA COVER

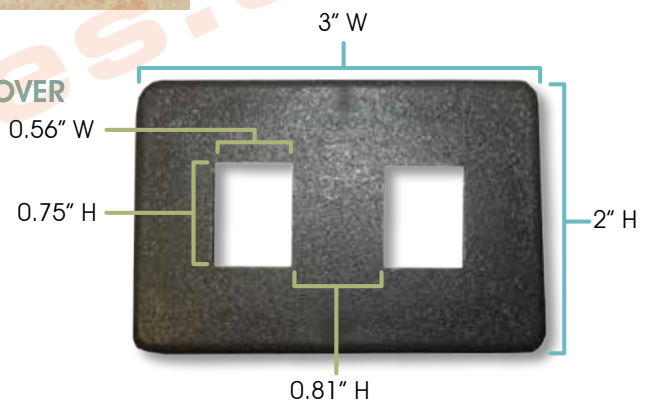

V1 POWER WITH DATA PUNCH OUTS

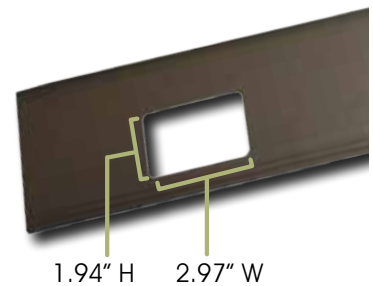

V2 POWER WITH DATA PUNCH OUTS

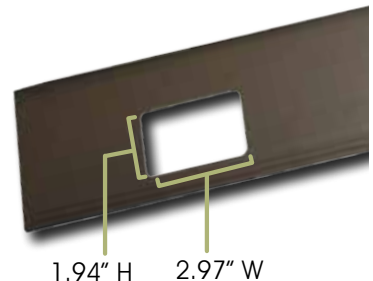

HEIGHT-ADJUSTABLE DESKS

Height Adjustable Bases

Input is 120V-60Hz, 400W

Output DC24V 5A/Linear Actuator

Duty Cycle 10% max. 2 min operate/min

Uses 1.5 amp during normal operation.

Max load is 175 lbs per leg, BIFMA also rates at 250 lbs in one location.

SINGLE BASE

E-TABLE-CORNER.BU

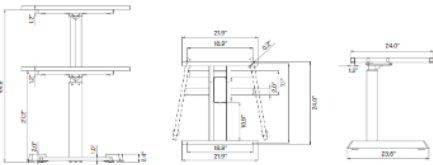

STRAIGHT BASE (2-STAGE) T-LEG

E-TABLE-2S-T-LEG.XX

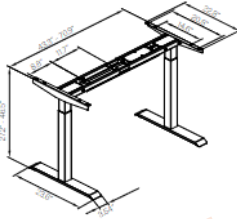

EXTENDED L BASE

E-TABLE-L-JXX

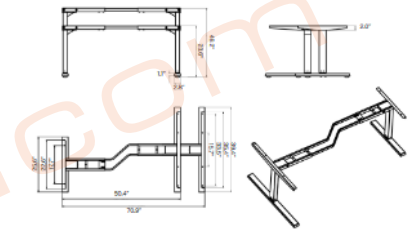

STRAIGHT BASE (2-STAGE) C-LEG

E-TABLE-2S-48-72-JXX

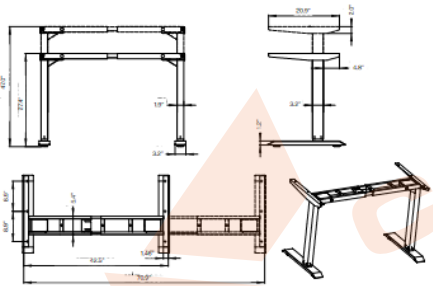

STRAIGHT BASE (3-STAGE) 90° BASE

E-TABLE-48-72-JXX
E-TABLE-48-72-90-JXX

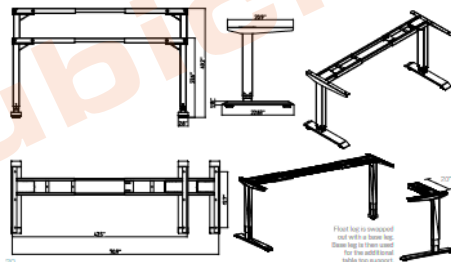

120° BASE

E-TABLE-120-JXX

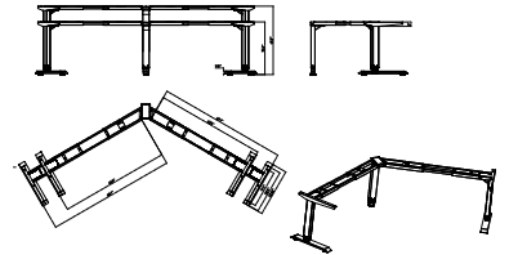

BASES - O2 CUBICLES

B2 - No Rubber Gaskets (OPS Standard)

Programs:

STANDARD with Signature Grade 1, Signature Grade 2 and 2 Week Quick Ship orders

Recommended for:

Those wanting cleaner lines, Lighter Base color options



2 Way



No Rubber Gaskets



End Cap

B1 - With Rubber Gaskets Standard with 1 Week Lightning (Optional with other programs)

Programs:

STANDARD with 1 Week Lightning
OPTIONAL with other orders (Signature Grade 1, Signature Grade 2, 2 Week Quick Ship Programs)

Recommended for:

Heavy Traffic, Telemarketing Stations, Matching up to Existing Stations, Panel Generated Hallways

NOTE: Only MT and BU are available in B1 Base.



2 Way



Rubber Gaskets



End Cap

TB - Razor System Panels (Optional)

NOTE: Base covers are shipped separately from the panels on Razor System orders

Programs:

Optional with all new Signature Program Only

Recommended for:

Modern Look, Chic Design, Streamline

Note:

V1 Power and Thin Receptacles required



2 Way- Panel



No Rubber Gaskets



End Cap



2 Way- Tile

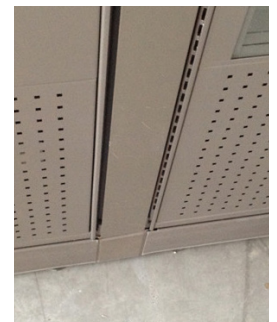

3 Way- Tile

ELECTRICAL ACCESS PANELS

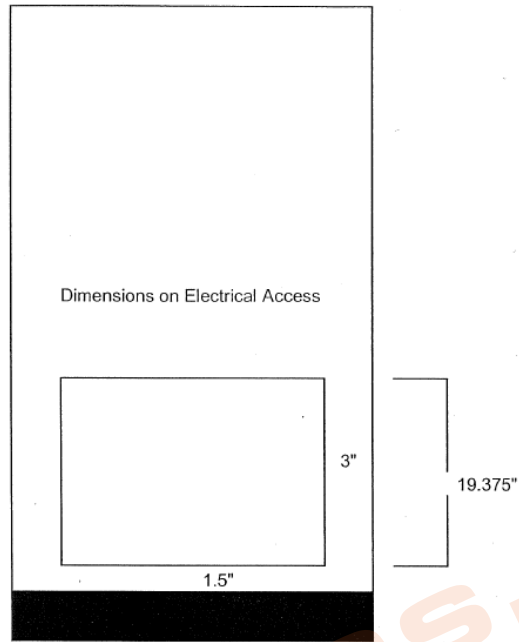

**Cut-outs used in NON-electrified panels as to allow access to the wall outlets.

